

Deviatore a due vie per montaggio bordo vasca - Champagne spazzolato (Oro 22k)

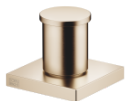









IMO

29 140 670



- deviatore automatico vasca/doccia
- diametro foro 32 mm
- rosetta 60 x 60 mm
- ingresso 1/2"
- portata max 64,9 l/min a una pressione idraulica di 3 bar

Compatibile con: IMO, MEM, CYO

	Champagne spazzolato (Oro 22k)	29 140 670-46
	Cromato	29 140 670-00
	Platinato spazzolato	29 140 670-06
	Platinato	29 140 670-08
	Dark Chrome	29 140 670-19
	Ottone spazzolato (Oro 23k)	29 140 670-28
	Nero opaco	29 140 670-33
	Champagne (Oro 22k)	29 140 670-47
	Cromo spazzolato	29 140 670-93
	Dark Platinum spazzolato	29 140 670-99

29 140 670
mm [inches]



Diagramma di portata



29 140 670
Parts for other
finishes can be found
here: Cromato

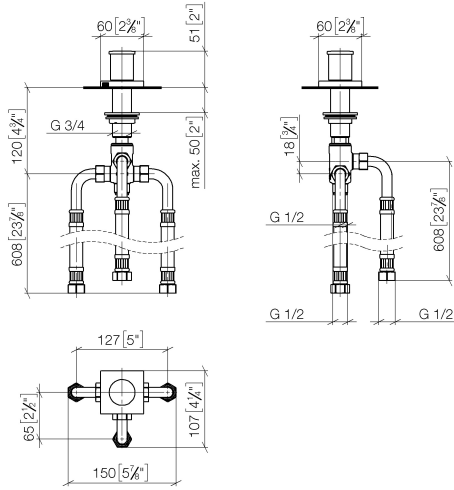
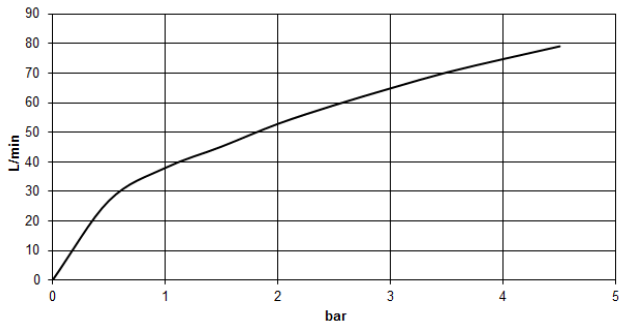
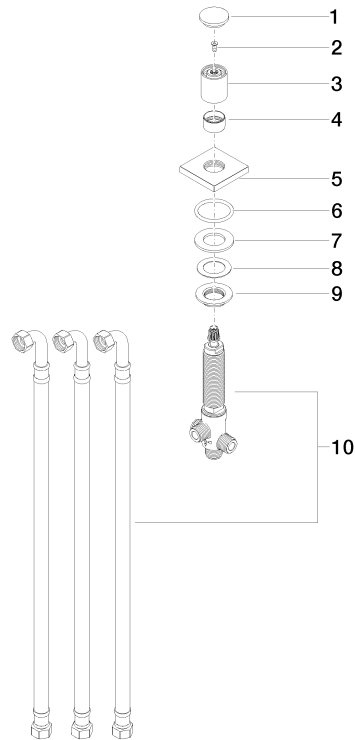

Elenco delle parti di ricambio

N.	Codice articolo	Denominazione	Quantità necessaria	Tempo di produzione
1	09 20 71 003-46	manopola	1	30
2	90 30 30 014 00 90	vite	1	2
3	09 20 71 002-46	manopola	1	30
4	09 16 01 012-46	anello	1	30
5	09 27 67 006-46	rosetta	1	30
6	90 14 10 043 00 90	guarnizione	1	2
7	09 14 05 014 90	guarnizione	1	2
8	09 14 40 002 90	guarnizione	1	2
9	09 23 10 004 90	dado	1	2
10	90 17 09 051 00 90	deviatore	1	2